

# Magnescape®

デジタルゲージ / 数字测量器 / Digital Gauge / Digitale Messtaster

## DK10 / DK25 Series

DK10PR5 / DK10NR5 / DK10PLR5

DK25PR5 / DK25NR5 / DK25PLR5 / DK25NLR5

お買い上げいただき、ありがとうございます。

ご使用前に、この取扱説明書を必ずお読みください。

ご使用に際しては、この取扱説明書どおりお使いください。

お読みになった後は、後日お役に立つこともございますので、必ず保管してください。

感谢您惠购本产品。

使用之前请务必认真阅读本手册，并且严格按照手册中的规定操作。

将此手册留作以后的参考。

Read all the instructions in the manual carefully before use and strictly follow them.

Keep the manual for future references.

Lesen Sie die ganze Anleitung vor dem Betrieb aufmerksam durch und folgen Sie beim Betrieb des Geräts den Anweisungen. Bewahren Sie diese Bedienungsanleitung zum späteren Nachlesen griffbereit auf.

取扱説明書 / 使用说明书 / Instruction Manual /  
Bedienungsanleitung

**[For U.S.A. and Canada]**

THIS CLASS A DIGITAL DEVICE COMPLIES WITH PART15 OF THE FCC RULES AND THE CANADIAN ICES-003. OPERATION IS SUBJECT TO THE FOLLOWING TWO CONDITIONS.

- (1) THIS DEVICE MAY NOT CAUSE HARMFUL INTERFERENCE, AND
- (2) THIS DEVICE MUST ACCEPT ANY INTERFERENCE RECEIVED, INCLUDING INTERFERENCE THAT MAY CAUSE UNDERSIGNED OPERATION.

CET APPAREIL NUMÉRIQUE DE LA CLASSE A EST CONFORME À LA NORME NMB-003 DU CANADA.

# Safety Precautions

---

Magnescale Co., Ltd. products are designed in full consideration of safety. However, improper handling during operation or installation is dangerous and may lead to fire, electric shock or other accidents resulting in serious injury or death. In addition, these actions may also worsen machine performance.

Therefore, be sure to observe the following safety precautions in order to prevent these types of accidents, and to read these “Safety Precautions” before operating, installing, maintaining, inspecting, repairing or otherwise working on this unit.

---

## Warning Indication Meanings

The following indications are used throughout this manual, and their contents should be understood before reading the text.



**Warning**

Failure to observe these precautions may lead to fire, electric shock or other accidents resulting in serious injury or death.



**Caution**

Failure to observe these precautions may lead to electric shock or other accidents resulting in injury or damage to surrounding objects.

---

## Symbols requiring attention



CAUTION



ELECTRICAL  
SHOCK

## Symbols prohibiting actions



DO NOT  
DISASSEMBLE



**Warning** Failing to follow the precaution items given below may lead to severe injury or death.



- Do not damage, modify, excessively bend, pull on, place heavy objects on or heat the cable, as this may damage the cable and result in fire or electric shock.



- Do not disassemble or modify the unit, as this may result in injury or electric shock. These actions may also damage the internal circuitry.



**Caution** Failing to follow the precaution items given below may lead to injury or damage to surrounding objects.



- The unit does not have an explosion-proof structure. Therefore, do not use the unit in an atmosphere charged with inflammable gases as this may result in fire.

## General precautions

When using Magnescale Co., Ltd. products, observe the following general precautions along with those given specifically in this manual to ensure proper use of the products.

- Before and during operations, be sure to check that our products function properly.
- Provide adequate safety measures to prevent damages in case our products should develop malfunctions.
- Use outside indicated specifications or purposes and modification of our products will void any warranty of the functions and performance as specified of our products.
- When using our products in combination with other equipment, the functions and performances as noted in this manual may not be attained, depending on operating and environmental conditions.



# Contents

<b>1. Operating Cautions .....</b>	<b>1</b>
<b>2. Mounting Instructions .....</b>	<b>2</b>
<b>3. Names of parts .....</b>	<b>3</b>
<b>4. Specifications .....</b>	<b>4</b>
<b>5. Measuring unit output signals .....</b>	<b>5</b>
5-1. Output Signal Phase Difference .....	5
5-2. Output Signal Alarm .....	6
5-3. Receiver .....	6
<b>6. Optional Accessories .....</b>	<b>7</b>
<b>7. Dimensions .....</b>	<b>8</b>





# 1. Operating Cautions

---

- Do not use the unit in places where it may receive excessive shocks. Otherwise the inside of the unit may be damaged or the unit may become unable to produce normal output signals.
- Be sure to turn off the power before connecting or disconnecting connectors in order to prevent damage or misoperation.
- After mounting the measuring unit, insert the connector into the display unit until it locks. Be sure to turn off the power switch before connecting or disconnecting the connector.
- Locate the measuring unit (head built-in portion) at least 10 cm away from a strong magnetic source. (Do not exceed 5 mT in parallel magnetic fields.)
- Do not forcibly pull the cable for connecting or disconnecting, or it may cause breakage.
- The measuring unit is short circuited to the frame GND (ground terminal) of the display unit by shield wire of the cable. When the measuring unit is used with another signal processing device on a machine tool, etc., be aware of the ground level.
- The N-type measuring unit has an unsealed spindle for use in mechanical devices and measuring rooms having a favorable work environment.  
Due to the low measurement force, the N-type cannot be used with the spindle directed upward.
- The P-type measuring unit is dust-proof, drip-proof, and oil-resistant making it suitable for use in environments subject to chips, cutting oil, and machine oils. However, avoid immersing the P-type in cutting oil, etc., as it is not of a water-proof structure.
- Adhesion of cutting oil, etc. which increases in viscosity after drying, may hinder accurate spindle motion. Remove them with water or tepid water. Then apply machine oil or the like to the spindle.
- The P-type measuring unit is provided on the sliding portion of the spindle with an anti-drip/dust seal of nitrile rubber. Spindle movement may be impaired by exposure to cutting oil, water, etc. that may remove oil from the spindle surface.
- Recommended calibration interval 1 year.

## 2. Mounting Instructions

- Be sure to chuck the stem for mounting the measuring unit. If other portion of the measuring unit needs to be chucked, avoid chucking the name label portion (where the head is built in) and its neighborhood (Fig. 1).  
If the measuring unit is mounted on another device, ensure that the measuring unit is free from contact with mount screws.
- If excessive torque is applied on the spindle when screwing in the feeler, the internal mechanisms can be damaged. Therefore, screw in the feeler with your hands, and never use a tool.  
Except when using a flat feeler, it is recommended to either attach the spring washer (nominal size: 2.5) or use a screw lock to prevent loosening of the feeler. (Tightening torque reference value: 0.05–0.06 N.m)
- The measuring unit comprises ball bearings. Therefore, chucking the stem of the measuring unit too tightly when mounting may damage the spindle and prevent its smooth motion.
- **A holder of dimensions as shown in Fig. 2 may be used to mount the measuring unit, tightening the screw to about 4 N-m torque.**
- Since mounting parallelism affects the measuring accuracy, adjust the parallelism to within 0.3 mm in relation to 100 mm displacement by means of mount bracket (or sleeve).
- Fix the cable in a suitable position to prevent possible cable breakage. Never handle the cable by forcibly pulling or bending it. (Inside bend radius 50 mm or more)
- If the spindle is to be fixed to the machine, use coupling DZ-191 which is optionally available. Refer to the DZ-191 Instruction Manual regarding the mounting procedure.
- After the stem is secured, do not apply force in the rotational direction. This could cause a failure.

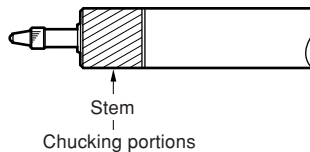

**Fig. 1 Mounting positions**

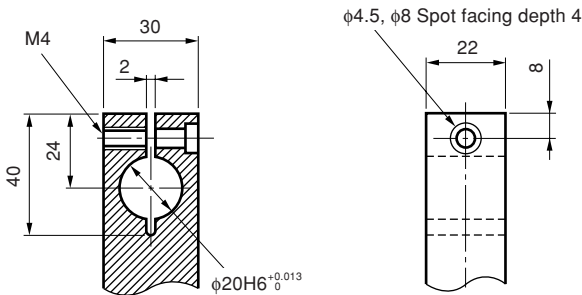

Tightening torque: 4 N-m  
Use 4M hexagon socket head cap screw.

**Fig. 2 Mount holder dimensions**

Unit: mm

### 3. Names of parts

---

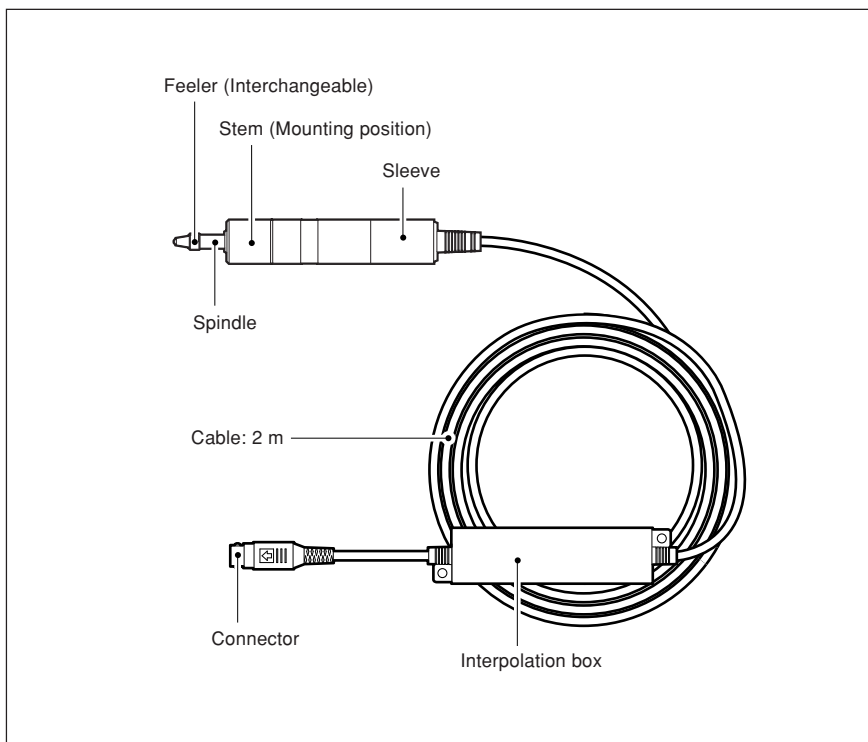

## 4. Specifications

	DK10NR5	DK10PR5	DK10PLR5	DK25NR5	DK25PR5	DK25NLR5	DK25PLR5
Output	A/B/Z phase voltage-differential line driver output (compliant with EIA-422)						
Resolution*1	0.5 $\mu$ m						
Measuring range	10 mm			25 mm			
Accuracy (at 20°C)	2 $\mu$ m						
Measuring force (at 20°C)	Upward	0.3 $\pm$ 0.25 N	4.9 N or less	0.4 $\pm$ 0.3 N	4.9 N or less	0.4 $\pm$ 0.3 N	4.9 N or less
	Horizontal	0.6 $\pm$ 0.3 N		0.7 $\pm$ 0.35 N		0.7 $\pm$ 0.35 N	
	Downward	0.8 $\pm$ 0.35 N		1 $\pm$ 0.4 N		1 $\pm$ 0.4 N	
Reference point	One location (at 1 mm position of spindle movement)						
Maximum response speed	250 m/min						
Vibration resistance (10 to 2000 Hz)	150 m/s <sup>2</sup>						
Impact resistance (11 ms)	1500 m/s <sup>2</sup>						
Protective structure	IP50	IP64		IP50	IP64	IP50	IP64
Operating temperature	0°C to 50°C						
Storage temperature	-20°C to 60°C						
Power supply voltage	DC +5 V $\pm$ 5%						
Power consumption	1 W or less						
Cable length	Approx. 2.5 m						
Diameter of stem	$\phi$ 20 <sup>+0</sup> <sub>-0.013</sub> mm						
Mass*2	Approx. 230 g			Approx. 300 g			
Feeler	Provided with a carbide ball tip DZ-122 (Mount screw M2.5)						
Output cable length (up to the electronic section)	22 m max.						
Life time	Minimum 5 million cycles without shock						
Accessories	+P M4×5 screw (2 pcs.), Instruction Manual						

### Note

- \*1 The resolution setting needs to be made when connecting to the LT30 series, MG series, and LY70 series. For details, please refer to the respective instruction manual.
- \*2 The mass indicated is the total mass excluding the cable and interpolation box.

# 5. Measuring unit output signals

The signals output from this measuring unit are phase A/B/Z signals in the form of voltage-differential line driver output compliant with EIA-422.

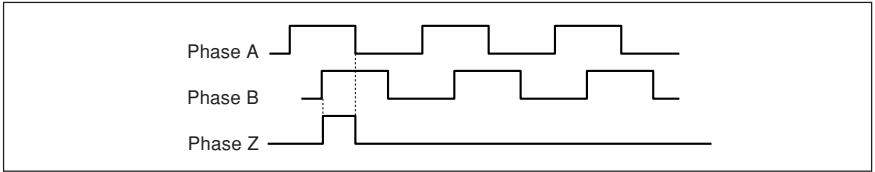

The reference point is the synchronized reference point that is at Hi level when the phase A and phase B are at the Hi level.

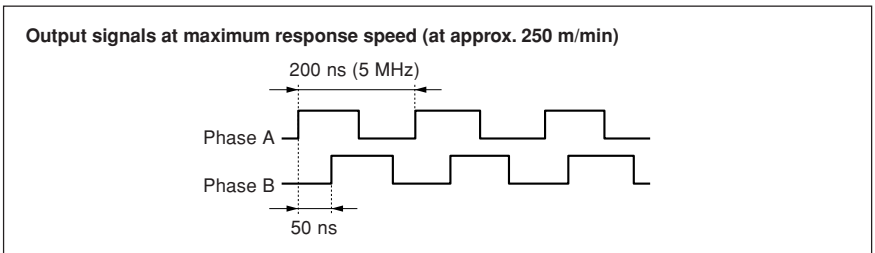

Before using, check that the minimum input phase difference of the control device connected to this measuring unit or the counter is smaller than 50 ns (phase A cycle: 200 ns, 5 MHz).

\* The minimum phase difference can be modified under special specifications. (See “5-1. Output signal phase difference”)

## 5-1. Output Signal Phase Difference

The travel amount of the measuring unit is detected every 50 ns, and the phase difference proportional to the amount traveled is output. The phase difference changes in integer multiples of 50 ns.

Also, the minimum phase difference for the phase A and phase B is 50 ns.

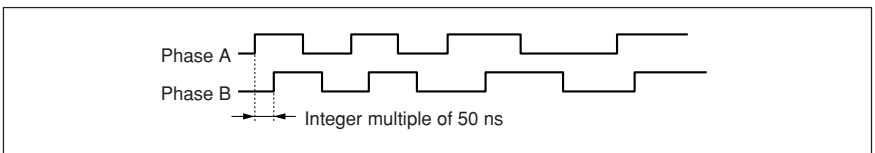

In the standard specifications, the minimum phase difference is fixed at 50 ns, but the minimum phase differences in the table below are available as special specifications.

A/B minimum phase difference	Phase A cycle	Counter allowable frequency	Maximum response speed (Resolution 0.5 $\mu\text{m}$ )	Remarks
50 ns	200 ns	5 MHz	250 m/min	Standard product
100 ns	400 ns	2.5 MHz	100 m/min	Special specifications
300 ns	1.2 $\mu\text{s}$	833 kHz	33 m/min	Special specifications
500 ns	2 $\mu\text{s}$	500 kHz	20 m/min	Special specifications

## 5-2. Output Signal Alarm

If the response speed is exceeded, the phase A/B output from this measuring unit changes to Hi level for about 400 ms to serve as an alarm.

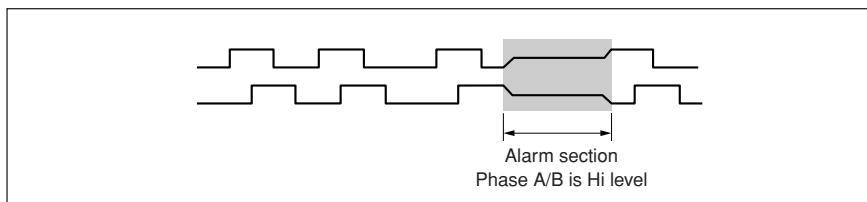

## 5-3. Receiver

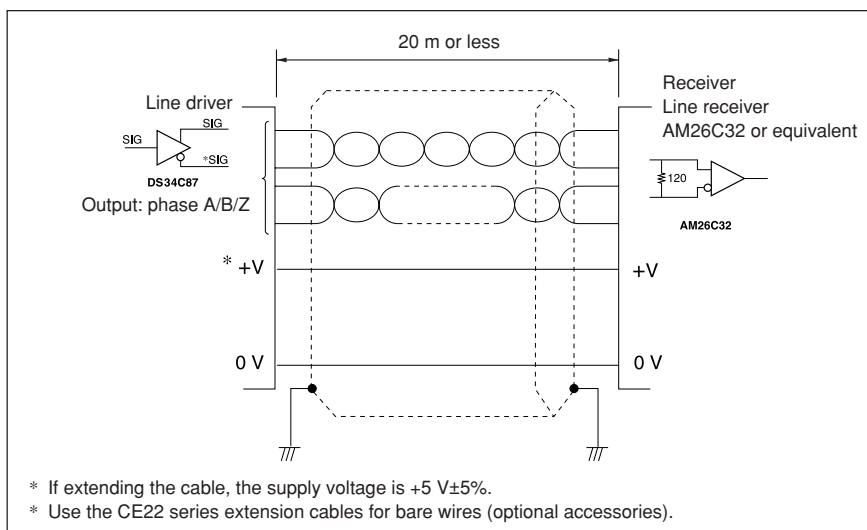

# 6. Optional Accessories

- Roller feeler: DZ-100

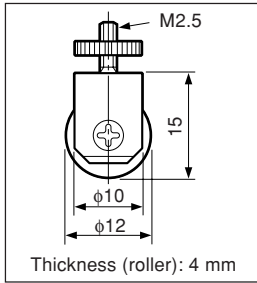

- Lift lever: DZ-161

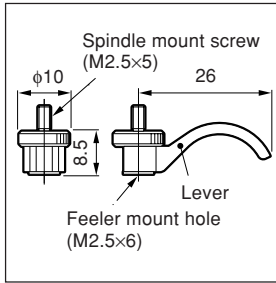

- Coupling: DZ-191

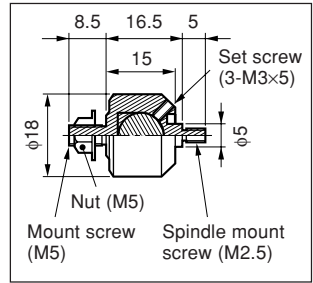

- Ceramic surface plate gauge stand: DZ-501

Surface plate size: 110×110 mm  
Mass: 13 kg

- Large stone surface plate gauge stand: DZ-531

Surface plate size: 350×350 mm  
Mass: 38 kg

- Extension cable

**CE22-01: 1 m, CE22-03: 3 m, CE22-05: 5 m, CE22-10: 10 m**

Bare wire colors	
Signal	Color
+Vcc	Red
0 V	White
A	Blue
$\bar{A}$	Yellow
B	Orange
$\bar{B}$	Gray
Z	Green
$\bar{Z}$	Violet

Cable length: 1, 3, 5, 10 m

**CK-T12: 1 m, CK-T13: 3 m, CK-T14: 5 m, CK-T15: 10 m**

Cable length: 1, 3, 5, 10 m

Unit: mm

- Connecting cable

This cable is for connecting the LY71/72, LH70/71 Series counter unit and DK Series measuring unit.

**CE29-003: 0.3 m, CE29-01: 1 m, CE29-03: 3 m, CE29-05: 5 m, CE29-10: 10 m**

Cable length: 0.3, 1, 3, 5, 10 m

Unit: mm





このマニュアルに記載されている事柄の著作権は当社にあり、説明内容は機器購入者の使用を目的としています。したがって、当社の許可なしに無断で複写したり、説明内容（操作、保守など）と異なる目的で本マニュアルを使用することを禁止します。

本手册所记载的内容的版权归属 Magnescale Co., Ltd.，仅供购买本手册中所记载设备的购买者使用。除操作或维护本手册中所记载设备的用途以外，未经Magnescale Co., Ltd.的明确书面许可，产禁复制或使本手册任何内容。

The material contained in this manual consists of information that is the property of Magnescale Co., Ltd. and is intended solely for use by the purchasers of the equipment described in this manual.

Magnescale Co., Ltd. expressly prohibits the duplication of any portion of this manual or the use thereof for any purpose other than the operation or maintenance of the equipment described in this manual without the express written permission of Magnescale Co., Ltd.

Le matériel contenu dans ce manuel consiste en informations qui sont la propriété de Magnescale Co., Ltd. et sont destinées exclusivement à l'usage des acquéreurs de l'équipement décrit dans ce manuel.

Magnescale Co., Ltd. interdit formellement la copie de quelque partie que ce soit de ce manuel ou son emploi pour tout autre but que des opérations ou entretiens de l'équipement à moins d'une permission écrite de Magnescale Co., Ltd.

Die in dieser Anleitung enthaltenen Informationen sind Eigentum von Magnescale Co., Ltd. und sind ausschließlich für den Gebrauch durch den Käufer der in dieser Anleitung beschriebenen Ausrüstung bestimmt. Magnescale Co., Ltd. untersagt ausdrücklich die Vervielfältigung jeglicher Teile dieser Anleitung oder den Gebrauch derselben für irgendeinen anderen Zweck als die Bedienung oder Wartung der in dieser Anleitung beschriebenen Ausrüstung ohne ausdrückliche schriftliche Erlaubnis von Magnescale Co., Ltd.

### 日本からの輸出時における注意

本製品 (および技術) は輸出令別表第1の16の項 (外為令別表16の項) に該当します。キャッチオール規制による経済産業省の許可要否につきましては、輸出者様にてご確認ください。

### For foreign customers

**Note:** This product (or technology) may be restricted by the government in your country. Please make sure that end-use, end user and country of destination of this product do not violate your local government regulation.

## 株式会社マグネスケール

〒259-1146 神奈川県伊勢原市鈴川45

## Magnescale Co., Ltd.

45 Suzukawa, Isehara-shi, Kanagawa 259-1146, Japan

DK10 / DK25 Series  
3-292-862-0B

このマニュアルは再生紙を使用しています。

2015.2  
Printed in Japan  
©2008 Magnescale Co., Ltd.